



# Micro Detectors

Italian Sensors Technology



## Q50 Cubic Photoelectric Sensor



## Photoelectric Sensors Catalogue

Cod. CAT3EQ51477601

Datasheet - Q50 - italiano - Ed.01/2014





Products

cubic  
Q50



# Series Q50

## Cubic



[www.microdetectors.com](http://www.microdetectors.com)

### market and sectors

wood industry  
packaging industry  
ceramic industry  
logistics and automated warehouses



## features

Compact cubic 50 x 50 mm universal photoelectric sensor, excellent performances and high versatility due to the wide choice of different versions available.

Cable output or revolving connector, NPN/PNP outputs for Vdc models or SPDT relay output for multi-voltage Vdc/Vac models.

Complementary outputs NO + NC available on the Vdc models or selectable output NO/NC available on the multi-voltage Vdc/Vac models.

Totally protected against electrical damages.

Wide choice of optical functions available: Diffuse: 2m

Background suppression: 500mm

Polarized: 6m

Through beam: 20m.

Dual multifunction output state LEDs

## approvals



## protection degree

IP67





Products

cubic  
Q50

## Q50 Cubic Photoelectric Sensor

Q50 Cubic Photoelectric Sensor Series, size 50 x 50 mm, offers a wide range of models:

- direct diffuse with working distance up to 2 m;
- background suppression up to 500 mm;
- polarized retro-reflective up to 6 m;
- through-beam with sensing range up to 20 m.

Available different versions: Vdc models with NPN/PNP and NO+NC selectable outputs. Multi-voltage Vdc/Vac models with relay output and NO/NC contacts available.

Compact housing provided with an M12 rotating connector or pre-wired cable allows to the user's an easy and fast installation, also in application with reduced space.

Highly visible LEDs simplify the alignment phase between sensor and target, besides the sturdiness of the housing guarantees a safe and reliable functioning of the product also in harsh environments. The mechanical protection is IP67 and the sensor is UL certified.

### pack content

Installation manual (English and Italian)

N° 1 mounting bracket + N° 2 screws with washers and bolts

Product packed in box

### further commercial and technical documents available

High resolution photos

### customization already tested

-

### minimum order quantity

1 piece

## descrizione del codice

	Q50	R	N	/	B	0	-	0	E
<b>Q50</b>	50x50 cubic photoelectric sensor								
<b>I</b>	Infrared emission								
<b>R</b>	Red emission								
<b>8</b>	Diffuse reflection								
<b>S</b>	Background Suppression								
<b>N</b>	Polarized								
<b>H</b>	Emitter								
<b>D</b>	Receiver								
<b>/</b>									
<b>B</b>	Complementary output NO+NC								
<b>0</b>	Emitter or NO/ NC selectable								
<b>0</b>	Emitter, NPN or PNP (Supply Voltage 10 ... 30Vdc)								
<b>T</b>	Emitter, Relay SPDT (Supply Voltage 12... 240 Vdc; 24...240 Vac)								
<b>-</b>									
<b>0</b>	Plastic housing								
<b>A</b>	Cable 2 m								
<b>E</b>	Connector M12 4 pins								

## available models

function	distance	adjustment	DC models		AC/DC models
			Cable	M12 connector	Cable
Diffuse	2 m	yes	Q50I8/B0-0A	Q50I8/B0-0E	Q50I8/0T-0A
Background suppression	120 ... 500 mm		Q50IS/B0-0A	Q50IS/B0-0E	-
Polarized	6 m		Q50RN/B0-0A	Q50RN/B0-0E	Q50RN/0T-0A
Emitter	20 m	no	Q50IH/00-0A	Q50IH/00-0E	Q50IH/0T-0A
Receiver	20 m	yes	Q50ID/B0-0A	Q50ID/B0-0E	Q50ID/0T-0A





Products

cubic  
Q50

## technical specifications (direct diffuse models)



according to IEC EN 60947-5-2 and IEC EN 60947-5-7

	 	
models	Q50I8/0T-**	Q50I8/B0-**
		
function	direct diffuse	
nominal sensing distance $S_n$	0.1 ÷ 2 m <sup>(2)</sup>	
minimum working distance	100 mm	
sensitivity adjustment	single-turn potentiometer	
emission	infrared LED	
spot dimension	80 mm ÷ 1 m	
light-dark selection	single-turn potentiometer	-
$U_e$ operating voltage	12 to 240 VDC / 24 to 240 VAC, 50 to 60 Hz	10 to 30 VDC (ripple included)
ripple	-	≤ 10%
no-load supply current	≤ 2.5 VA(relay ON)	≤ 40 mA
load current	-	≤ 200 mA
output voltage drop $U_d$	-	≤ 2.5 VDC @ 200 mA
maximum load current	3 A/30 VDC 3 A/250 VAC	-
output type	relay SPDT electrically isolated	PNP or NPN
switching frequency $f$	20 Hz	500 Hz
time delay before availability	≤ 30 ms	-
supply electrical protections	transients	inversione di polarità sovratensione impulsiva
output electrical protection	-	Sovracorrenti, corto circuito, extratensioni
operative temperature range	- 20 ... + 60° C	
interference external light	5.000 Lux	
EMC	Conforming to the EC Directive 2004/108/EC requirements according to EN 60947-5-2	
protection degree	IP67 (EN60529) <sup>(3)</sup>	
housing material	Body: PC/ABS; Optic: PMMA	
weight (approx)	110 g	110 g cable 32 g connector

<sup>(1)</sup> with RL 110 reflector<sup>(2)</sup> White target 90% 200\*200mm<sup>(3)</sup> protection guaranteed only with plug cable well mounted

## technical specifications (background suppression models)

according to IEC EN 60947-5-2 and IEC EN 60947-5-7

	
models	Q50IS/0B-**
	
function	background suppression
nominal sensing distance $S_n$	120 ÷ 500 mm <sup>(2)</sup>
minimum working distance	120 mm
sensitivity adjustment	single-turn potentiometer
emission	infrared LED
spot dimension	30 mm ÷ 500 mm
light-dark selection	-
$U_e$ operating voltage	10 to 30 VDC (ripple included)
ripple	≤ 10%
no-load supply current	≤ 40 mA
load current	≤ 200 mA
output voltage drop $U_d$	≤ 2.5 VDC @ 200 mA
maximum load current	-
output type	PNP or NPN
switching frequency $f$	500 Hz
time delay before availability	≤ 2 ms
supply electrical protections	polarity reversal, over voltage pulses
output electrical protection	short circuit (auto reset) , over voltage pulses
operative temperature range	- 20 ...+ 60° C
interference external light	10.000 Lux
EMC	Conforming to the EC Directive 2004/108/EC requirements according to EN 60947-5-2
protection degree	IP67 (EN60529) <sup>(3)</sup>
housing material	Body: PC/ABS; Optic: PMMA
weight (approx)	130 g / 32 g

<sup>(1)</sup> with RL 110 reflector

<sup>(2)</sup> White target 90% 200\*200mm

<sup>(3)</sup> protection guaranteed only with plug cable well mounted



Products

cubic  
Q50

## technical specifications (polarized models)

according to IEC EN 60947-5-2 and IEC EN 60947-5-7



models	Q50RN/0T-**-**		Q50RN/B0-**-**	
function	polarized			
nominal sensing distance $S_n$	0.2 ÷ 6 m <sup>(1)</sup>			
minimum working distance	200 mm			
sensitivity adjustment	single-turn potentiometer			
emission	red visible LED light			
spot dimension	280 mm ÷ 3 m			
light-dark selection	single-turn potentiometer		-	
$U_e$ operating voltage	12 to 240 VDC / 24 to 240 VAC, 50 to 60 Hz		10 to 30 VDC (ripple included)	
ripple	-		≤ 10%	
no-load supply current	≤ 2.5 VA (relay ON)		≤ 40 mA	
load current	-		≤ 200 mA	
output voltage drop $U_d$	-		≤ 2.5 VDC @ 200 mA	
maximum load current	3 A/30 VDC 3 A/250 VAC		-	
output type	relay SPDT electrically isolated		PNP or NPN	
switching frequency $f$	20 Hz		500 Hz	
time delay before availability	-		≤ 1 ms	
supply electrical protections	transients		reverse polarity, transients	
output electrical protection	-		overvoltage, short-circuit	
operative temperature range	- 20 ... + 60° C			
interference external light	5.000 Lux			
EMC	conforming to the EC Directive 2004/108/EC requirements according to EN 60947-5-2			
protection degree	IP67 (EN60529) <sup>(3)</sup>			
housing material	Body: PC/ABS; Optic: PMMA			
weight (approx)	110 g		110 g cable 32 g connector	

<sup>(1)</sup> with RL 110 reflector<sup>(2)</sup> White target 90% 200\*200mm<sup>(3)</sup> protection guaranteed only with plug cable well mounted

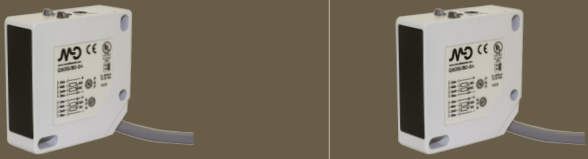

## technical specifications (emitter models)

according to IEC EN 60947-5-2 and IEC EN 60947-5-7

		
models	Q50IH/00-**	Q50IH/0T-**
		
function	emitter	
nominal sensing distance $S_n$	20 m	
minimum working distance	-	
sensitivity adjustment	-	
emission	infrared LED	
spot dimension	880 mm $\div$ 10 m	
light-dark selection	-	
$U_e$ operating voltage	10 to 30 VDC (ripple included)	12 to 240 VDC / 24 to 240 VAC, 50 to 60 Hz
ripple	$\leq 10\%$	-
no-load supply current	$\leq 50$ mA	$\leq 2.5$ VA (relay ON)
load current	-	
output voltage drop $U_d$	-	
maximum load current	-	
output type	-	
switching frequency $f$	-	
time delay before availability	-	
supply electrical protections	reverse polarity, transients	transients
output electrical protection	-	
operative temperature range	- 20 ...+ 60° C	
interference external light	-	
EMC	conforming to the EC Directive 2004/108/EC requirements according to EN 60947-5-2	
protection degree	IP67 (EN60529) <sup>(3)</sup>	
housing material	Body: PC/ABS; Optic: PMMA	
weight (approx)	110 g cable 32 g connector	110 g

<sup>(1)</sup> with RL 110 reflector

<sup>(2)</sup> White target 90% 200\*200mm

<sup>(3)</sup> protection guaranteed only with plug cable well mounted







Products

cubic  
Q50

## technical specifications (receiver models)

according to IEC EN 60947-5-2 and IEC EN 60947-5-7

	 <b>Q50ID/B0-<sup>**</sup></b>	 <b>Q50ID/0T-<sup>**</sup></b>
models		
function	receiver	
nominal sensing distance $S_n$	20 m	
minimum working distance	-	
sensitivity adjustment	single-turn potentiometer	
emission	-	
spot dimension	-	
light-dark selection	-	single-turn potentiometer
$U_e$ operating voltage	10 to 30 VDC (ripple included)	12 to 240 VDC / 24 to 240 VAC, 50 to 60 Hz
ripple	$\leq 10\%$	-
no-load supply current	$\leq 40$ mA	$\leq 2.5$ VA (relay ON)
load current	$\leq 200$ mA	-
output voltage drop $U_d$	$\leq 2.5$ VDC @ 200 mA	-
maximum load current	-	3 A/30 VDC 3 A/250 VAC
output type	PNP o NPN	contatto pulito di relè in scambio
switching frequency $f$	500 Hz	20 Hz
time delay before availability	$\leq 1$ ms	-
supply electrical protections	reverse polarity, transients	transients
output electrical protection	overvoltage, short-circuit	-
operative temperature range	- 20 ...+ 60° C	
interference external light	10.000 Lux	
EMC	conforming to the EC Directive 2004/108/EC requirements according to EN 60947-5-2	
protection degree	IP67 (EN60529) <sup>(3)</sup>	
housing material	Body: PC/ABS; Optic: PMMA	
weight (approx)	110 g cable 32 g connector	110 g

<sup>(1)</sup> with RL 110 reflector<sup>(2)</sup> White target 90% 200\*200mm<sup>(3)</sup> protection guaranteed only with plug cable well mounted

BN	brown
BU	blue
BK	black
WH	white

## electrical diagrams of connections

### M12

Background suppression, polarized retroreflection and receiver with PNP output

Background suppression, polarized retroreflection and receiver with NPN output

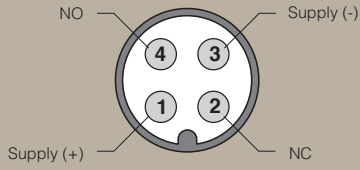

- Q50RN/B0-\*\*
- Q50I8/B0-\*\*
- Q50IS/B0-\*\*
- Q50ID/B0-\*\*

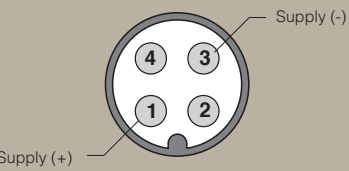

- Q50IH/00-\*\*

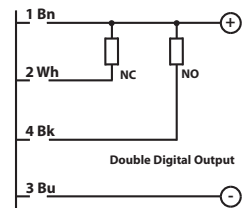
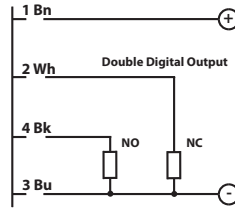

DC emitter

AC/DC emitter

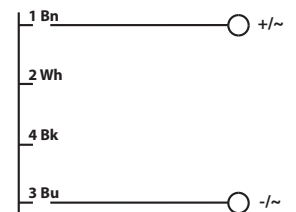
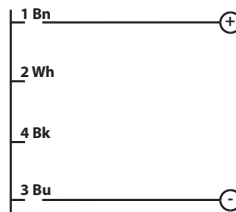

Background suppression, polarized retroreflection and receiver with NPN output

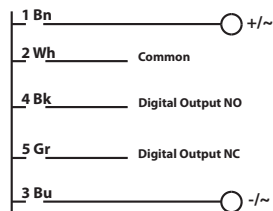



Products

cubic  
Q50

## response diagrams

### Q50IS/\*\*\_\*\*

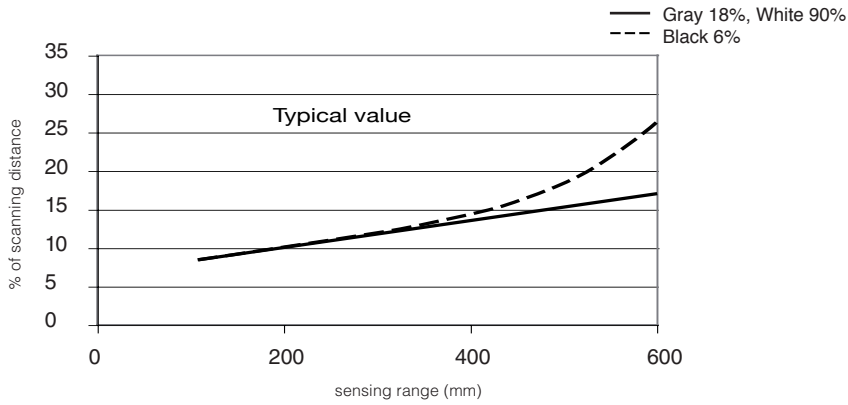

### Q50I8/\*\*\_\*\*

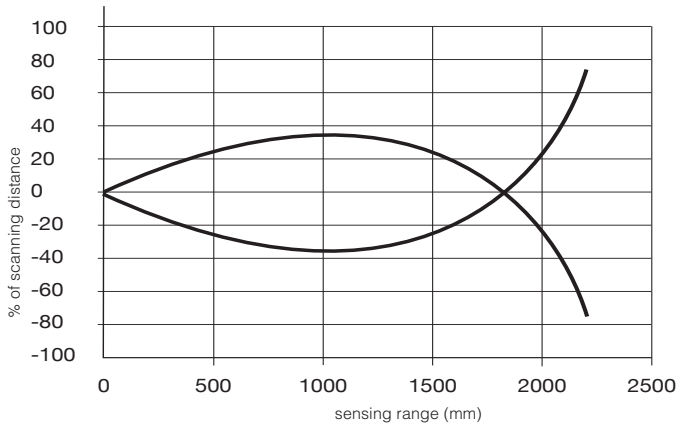

### Q50RN/\*\*\_\*\*

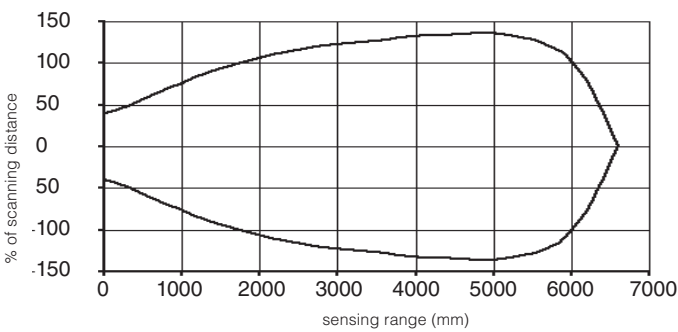

### Q50IH/\*\*\_\*\* & Q50ID/\*\*\_\*\*

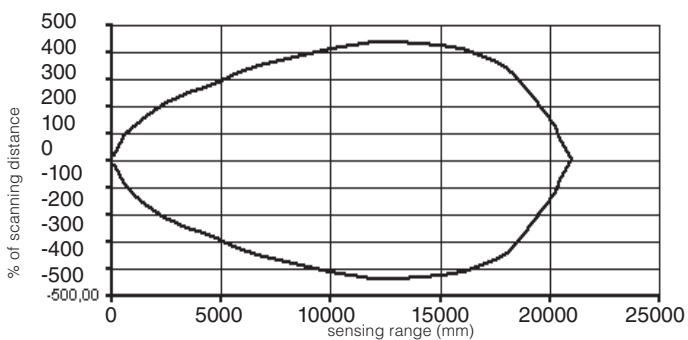

Connector

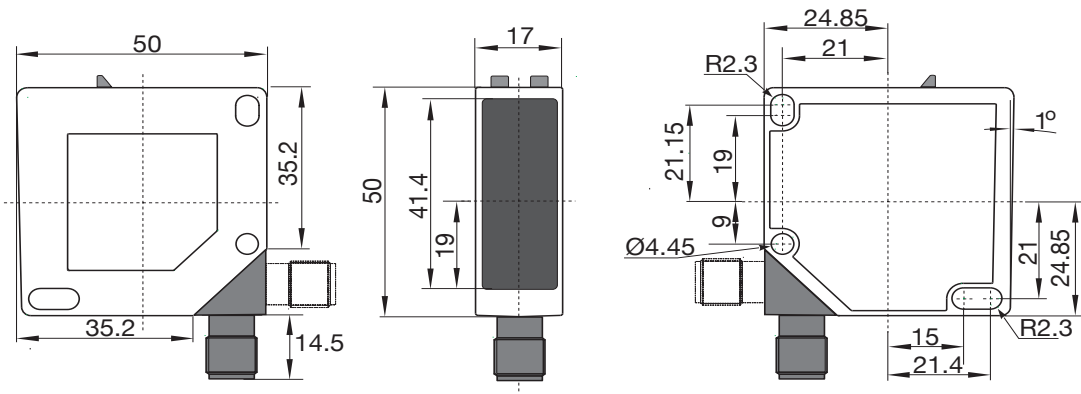

mm

Cable

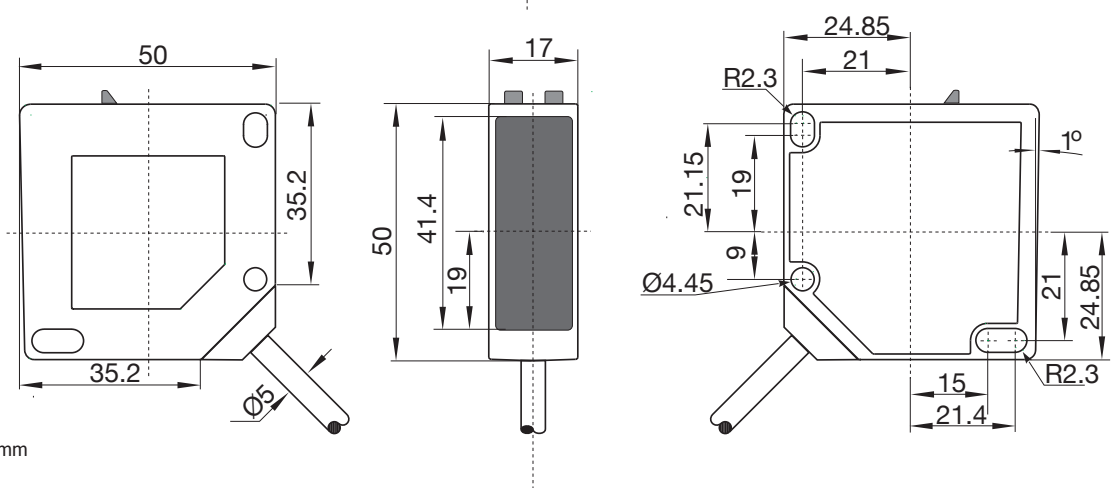

mm

Q5018/\*\*-\*\* - Q50RN/\*\*-\*\*Q50ID/\*\*-\*\*

Q50IS/\*\*-\*\*

Q50IH/\*\*-\*\*

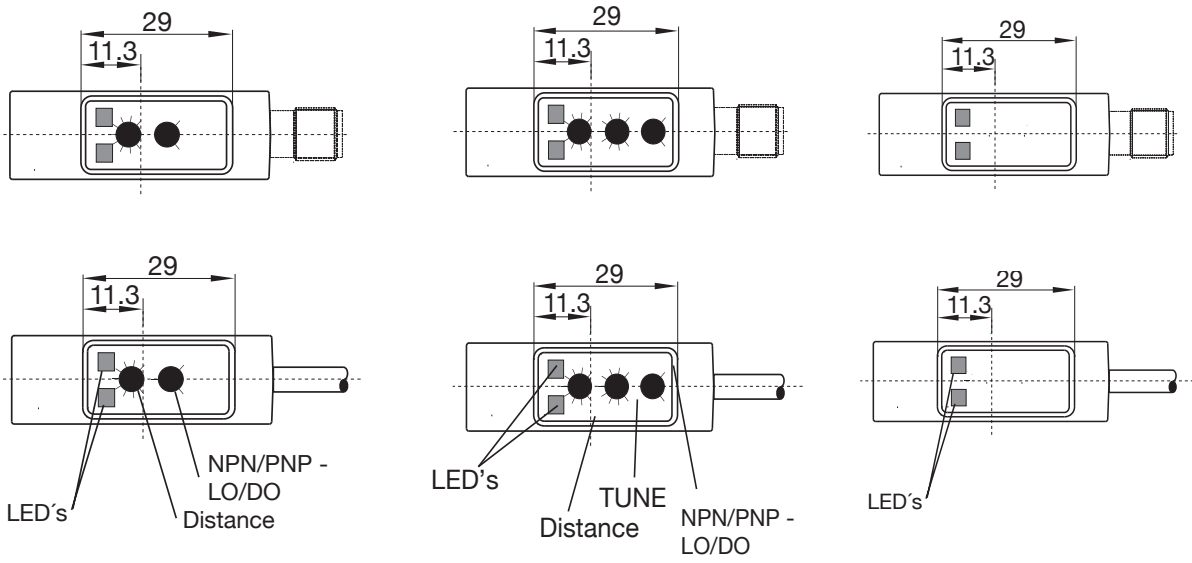

mm



Catalogue  
Photoelectric Sensors



CAT3EQ51477601 Q50 CUBIC MINIATURIZED PHOTOELECTRIC SENSOR ITA ED.01/2014

All information written in this catalogue are subject to modifications without notice.  
They don't represent any obligation for M.D. Micro Detectors

Any variation will be implemented in this catalogue and its electronic version, available on the corresponding page of M.D. Micro Detectors website:  
[www.microdetectors.com](http://www.microdetectors.com)